

Would You Bet Your Life On Your Magazine?

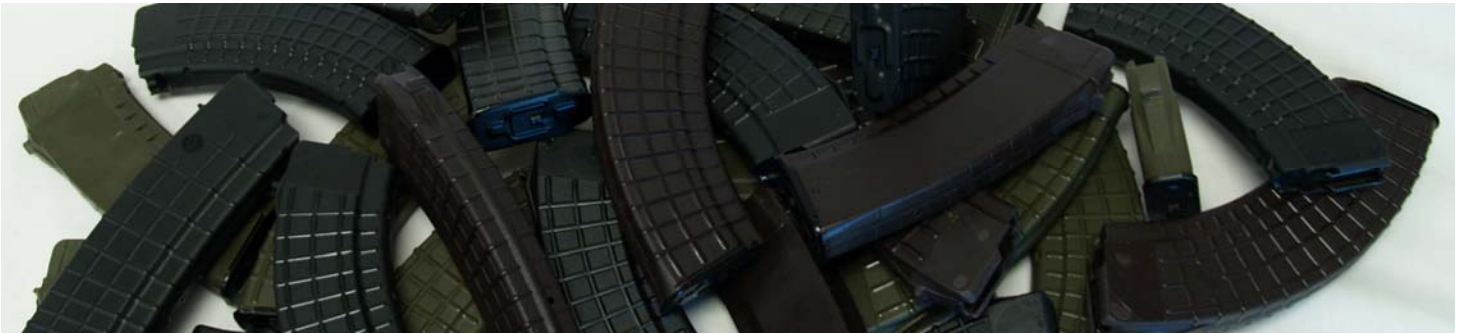

Arsenal Inc. designed this free circular to educate our customers about the benefits of a genuine Arsenal magazine and the hazards of poorly designed and manufactured after-market magazines.

THE BEST RIFLES NEED
THE BEST MAGAZINES



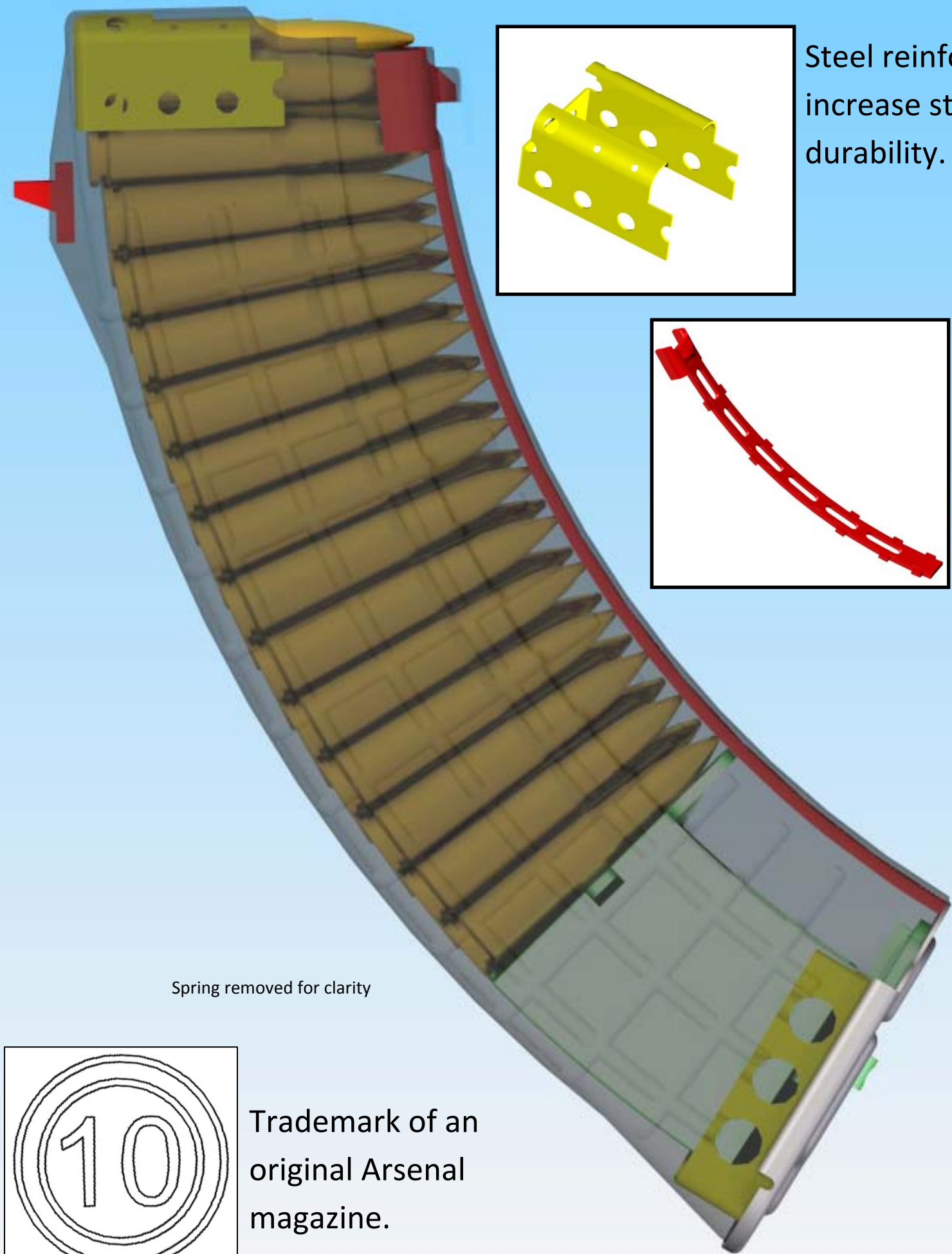

Spring removed for clarity

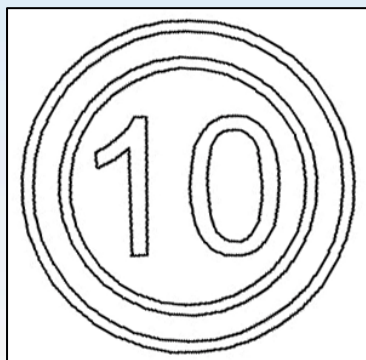

Trademark of an original Arsenal magazine.

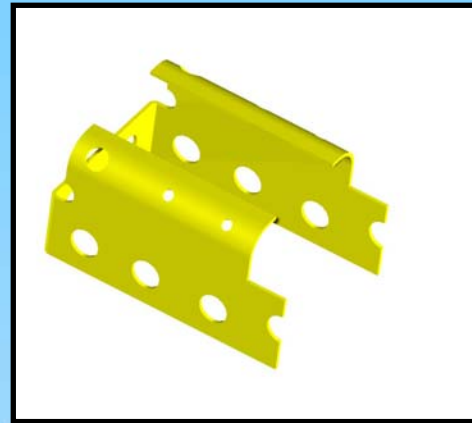

Steel reinforced feed lips increase strength and durability.

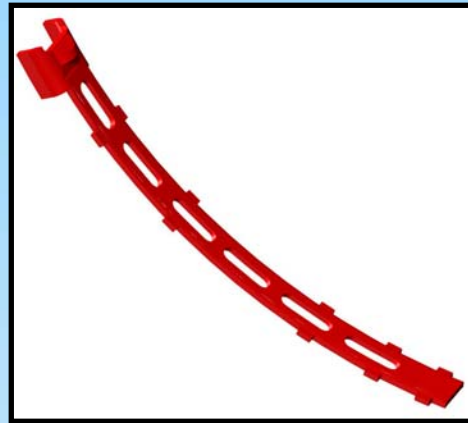

Metal front strap protects magazine from bullet points, gives rigidity, and a steel lug for magazine retention.

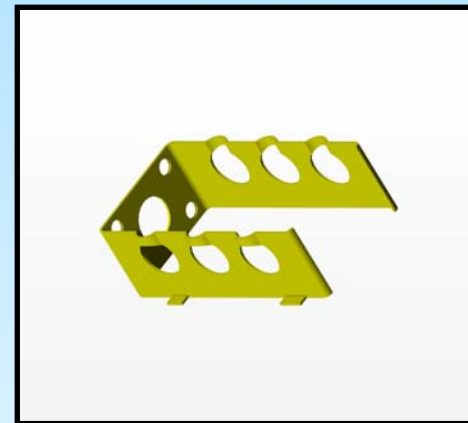

The bottom rails are strengthened with a steel insert.



Steel floorplate safely secures all moving parts

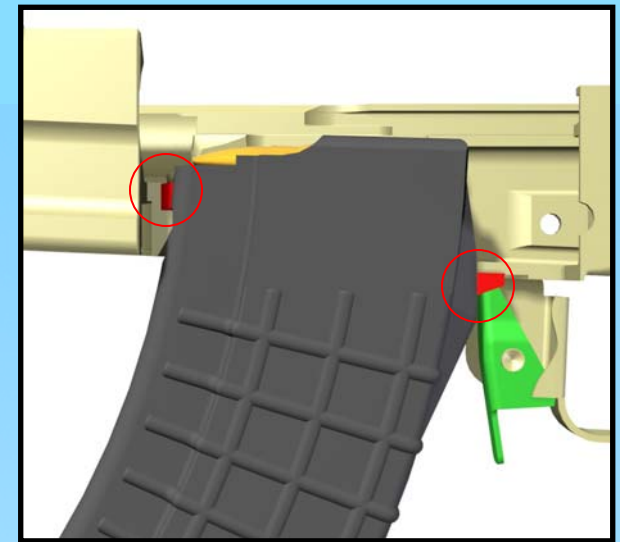

The wear resistant steel lugs are machined to factory specs to guarantee perfect fit and function.

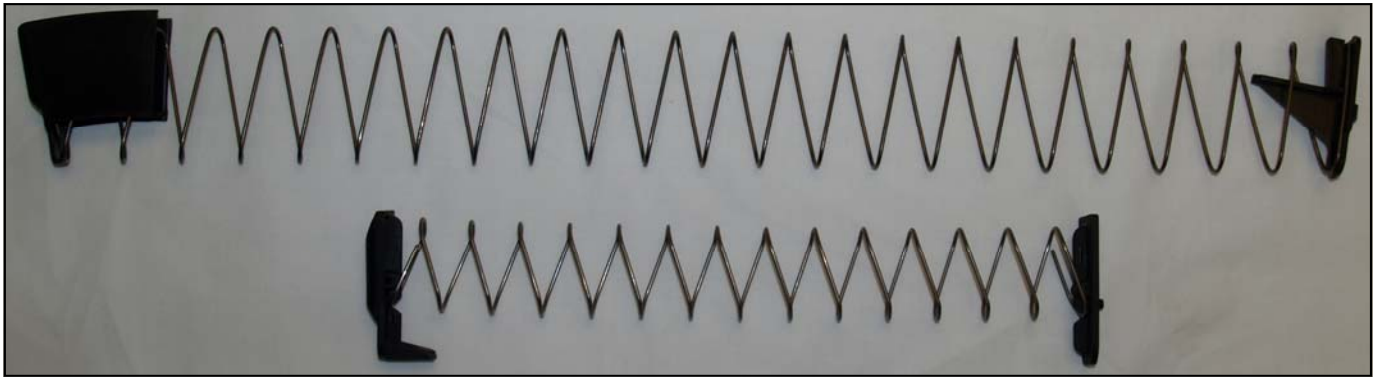

Our powerful spring (top) is full size with more turns for long life and reliability.



Our follower (right) will not tilt in the magazine or cause a jam.

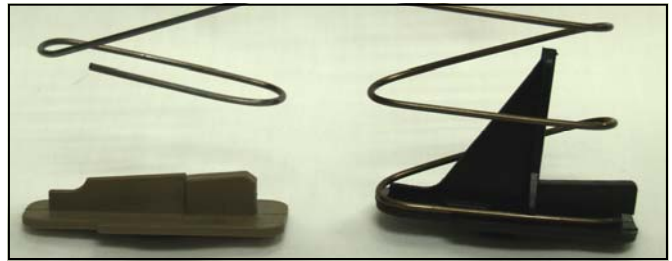

The keeper on the left can fly off during disassembly. Our keeper (right) is captive and has a spring guide to prevent binding.



The magazine on the left does not have the correct shape, and it binds in the rifle. Our magazine (right) is machined on four sides for a perfect fit.



Our metal floor plate (right) has ribs designed to give it strength. The plastic floorplate is bulkier, and the ribs are purely cosmetic, to give the appearance of the original.



For high quality parts and accessories for your Arsenal rifle or any other variant please contact K-VAR Corporation.
Phone: (702) 364-8880 www.k-var.com